

Horizon HZD1120D

Art. no. HZD1120D
GTIN 7393069011210

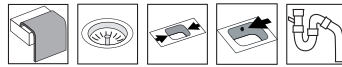

Art. no. HZD1120DF
GTIN 7393069011234

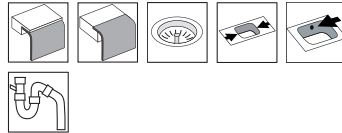

Art. no. HZD1120DR
GTIN 7393069011296

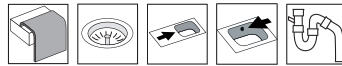

Art. no. HZD1120DRF
GTIN 7393069011319

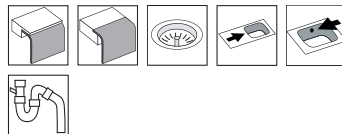

Art. no. HZD1120DL
GTIN 7393069011258

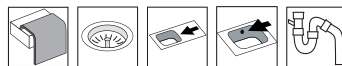

Art. no. HZD1120DLF
GTIN 7393069011272

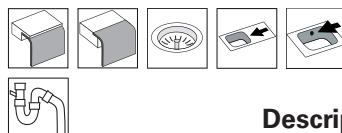

Cabinet size 80
Overall dimension in mm 1120 x 510
Bowl dim. in mm 345 x 415 x 160
Small bowl dim. in mm 345 x 415 x 160
Cut-out dimension, inset model 1099 x 468
Waste hole dim. in mm 97
Waste hole placement center
Material EN 1.4301, AISI 304, SS2333
Material thickness in mm 0,7
Pcs per pallet 13
Design OddThorsen

Description

Reversible kitchen sink with two big bowls and drainage surface for inset, under- or flushmounting. Delivers with basket wastes, overflow in one bowl, tap hole cover and water trap.

Separate article number for under/flushmounting: HZD1120DF
Also available with one taphole (bowls right or left)

Optional

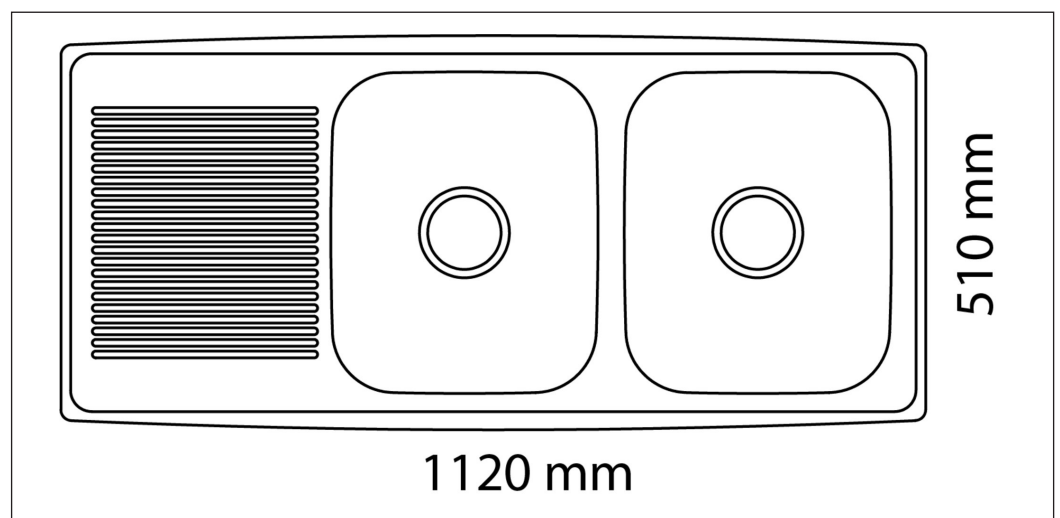

510 mm

1120 mm

