

Ausschnitt M 1:20

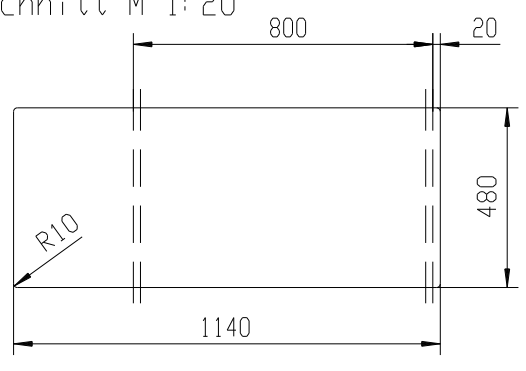

				Maßstab 1:10	
				Domus D-200	
2003	Datum	Name			
Bearb.	03. 06.	H?			
Gepr.					
				4. 03. 655. 04. 00	
				1 Bl.	
Zust.	Änderung	Datum	Name		

**SCHOCK** Hofbauerstraße 1 à D-94209 REGEN