

# Wash trough P9

**Art. no.** P9-1500  
**GTIN** 8719585005288



**Overall dimension in mm** 1500 x 395 x 163  
**Outlet dimension in mm** 1 1/2"  
**Material** Stainless steel 18/10, AISI304, 1.4301  
**Material thickness in mm** 1 / 1,5  
**Installation height in mm** 500/800/900  
**Gross weight in kg** 10.40  
**Net weight in kg** 8.90

## Description

Flexible wash trough supplied with integrated wall brackets. Inner corners with more than 90° angle, and pressed drain without screws and gasket ensure optimum hygiene and easy cleaning. The bowl has a fall against the drain in the center. Soft transitions at all external angles counteract damage in the event of a fall against the trough. Safe and comfortable handle support at the bottom of the edges to prevent damage during assembly.

Meets all requirements in EN 14296.

Washtroughs available in standard lengths 600, 1200, 1500, 1800, 2100, 2400, 2800 and 3000 mm.

Washtroughs also available in any customer specified length between 600 and 3000. Art. Nr: P9-Flex

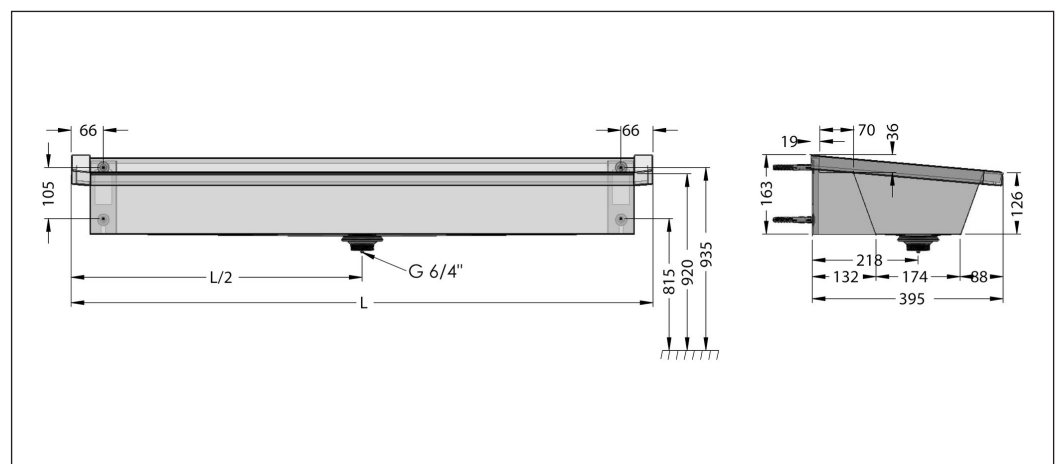

# Installation P9

The wash trough is mounted to the wall with four fixing screws through the two wall brackets at the rear. Hang the wash trough on the bottom screws without tightening, and lock it to the wall via the fastening holes.

# Maintenance P9

In order for your stainless steel product to maintain its original quality and appearance, we recommend regular cleaning. Use mild soap or detergents specially designed for stainless steel and clean water. Then wipe the surface with a dry cloth. Never use cleaners containing chlorine, iodine, fluorine or abrasives on stainless steel.

Also avoid contact with acid solutions and other substances that are not compatible with stainless steel. Remember that, for example, foods and skin care products can contain such substances, such as ketchup, juice, salt and nail polish. Remove immediately.

Never use scouring powder or steel wool on stainless steel. In addition to scratching the steel, steel wool leaves behind small particles that can develop into

rust spots that can over time attack the steel.

Please note the following:

- Do not allow water or other liquid to dry. This is to prevent surface blemishes.
- Although stainless steel can withstand hard handling, scratches of sharp objects can easily be achieved. For products with a normally polished (brushed) finish, this will seem good when the product is new, but after a period of use it will even out without the steel losing its gloss. For satin and grinded finish products, the scratches will always be clearly visible.
- Stainless steel AISI 304 must not be in contact with, or in environments with chlorine solutions for long periods of time.

